

anbai **Applent** Instruments
INSTRUMENTS

Applent Instruments Inc.

Baolong International FL3, Chahua Road,
Zhonglou district, Changzhou City, Jiangsu
Province, China [213014]

Tel: 0519-88805550 Fax: 0519-89966550

<http://www.applent.com>

Sales Email: sales@applent.com

Tech Email: tech@applent.com

©2005-2016 Applent Instruments, Inc.

English

Rev.A0

[AT4108/4116 Multi-channel Temperature Meter]

User's Guide

Safety Summary

 Warning  Dangerour :

The following general safety precautions must be observed during all phases of operation, service, and repair of this instrument. Failure to comply with these precautions or with specific WARNINGS elsewhere in this manual may impair the protection provided by the equipment. In addition it violates safety standards of design, manufacture, and intended use of the instrument.

Disclaimer

The Applent Instruments assumes no liability for the customer's failure to comply with these requirements.

Ground
The Instrument

To avoid electric shock hazard, the instrument chassis and cabinet must be connected to a safety earth ground by the supplied power cable with earth blade.

DO NOT
Operate In An Explosive
Atmosphere

Do not operate the instrument in the presence of inflammable gasses or fumes. Operation of any electrical instrument in such an environment constitutes a definite safety hazard.

Keep away
from live circuit

Operating personnel must not remove instrument covers. Component replacement and internal adjustments must be made by qualified maintenance personnel. Do not replace components with the power cable connected. Under certain conditions, dangerous voltages may exist even with the power cable removed. To avoid injuries, always disconnect power and discharge circuits before touching them.

Operations not
included in the manual are
forbidden

The protection measurements will be failure while beyond the scope.



Warning: TO AVOIDE INSTRUMENT DAMAGED, PLEASE DO NOT PUT DC VOLT OR CURRENT IN THE TESR TERMINAL MAKE SURE THE CAPACITOR IS DISCHARGED BEFORE TESTING

Safety Sign:



Provide double insulation or reinforced insulation protection

Waste Electrical and Electronic Equipment (WEEE) order 2002/96/EC



Do not leave in the trash can

CERTIFICATION, LIMITED & LIMITATION OF LIABILITY

Applent Instruments, Inc. (shortened form **Applent**) certifies that this product met its published specifications at the time of shipment from the factory. Applent further certifies that its calibration measurements are traceable to the People's Republic of China National Institute of Standards and Technology, to the extent allowed by the Institution's calibration facility or by the calibration facilities of other International Standards Organization members.

This Applent instrument product is warranted against defects in material and workmanship for a period corresponding to the individual warranty periods of its component products. **The warranty period is 1 year and begins on the date of shipment.** During the warranty period, Applent will, at its option, either repair or replace products that prove to be defective. This warranty extends only to the original buyer or end-user customer of a Applent authorized reseller, and does not apply to fuses, disposable batteries or to any product which, in Applent's opinion, has been misused, altered, neglected or damaged by accident or abnormal conditions of operation or handling.

For warranty service or repair, this product must be returned to a service facility designated by Applent. The buyer shall prepay shipping charges to Applent and the Buyer shall pay all shipping charges, duties, and taxes for products returned to Applent from another country.

Applent warrants that its software and firmware designated by Applent for use with an instrument will execute its programming instruction when properly installed on that instrument. Applent does not warrant that the operation of the instrument, or software, or firmware, will be uninterrupted or error free.

The foregoing warranty shall not apply to defects resulting from improper or inadequate maintenance by the Buyer, Buyer-supplied software or interfacing, unauthorized modification or misuse, operation outside the environmental specifications for the product, or improper site preparation or maintenance.

THIS WARRANTY IS BUYER'S SOLE AND EXCLUSIVE REMEDY AND IS IN LIEU OF ALL OTHER WARRANTIES, EXPRESS OR IMPLIED, INCLUDING BUT NOT LIMITED TO ANY IMPLIED WARRANTY OF MERCHANTABILITY OR FITNESS FOR A PARTICULAR PURPOSE. APPLMENT SHALL NOT BE LIABLE FOR ANY SPECIAL, INDIRECT, INCIDENTAL OR CONSEQUENTIAL DAMAGES OR LOSSES, INCLUDING LOSS OF DATA, WHETHER ARISING FROM BREACH OF WARRANTY OR BASED ON CONTRACT, TORT, RELIANCE OR ANY OTHER THEORY.

People's Republic of China
Jiangsu Province
Changzhou Applent Instruments Inc.
Oct. 2009
Rev.A1

Contents

<i>Safety Summary</i>	2
<i>CERTIFICATION, LIMITED & LIMITATION OF LIABILITY</i>	3
<i>Contents</i>	4
1. Unpacking and Inspection	6
1.1 <i>Packing List</i>	6
1.2 <i>Power Supply</i>	6
1.3 <i>Operation Environment</i>	6
1.4 <i>Cleaning</i>	6
1.5 <i>Instrument Handle</i>	6
2. Overview	8
2.1 <i>Introduction</i>	8
2.2 <i>Main Specifications</i>	8
2.3 <i>Main Functions</i>	8
2.3.1 <i>Functions</i>	8
2.3.2 <i>Sorting Setting</i>	8
2.3.3 <i>Correction Function</i>	8
2.3.4 <i>FAT Save Function</i>	8
2.3.5 <i>System Setting</i>	8
2.3.6 <i>Remote Control</i>	8
3. Startup	9
3.1 <i>A tour of front and back panel</i>	9
4. [Meas] Page	11
4.1 <i><MEASURE DISPLAY> Page</i>	11
4.1.1 <i>[MODEL]</i>	11
4.1.2 <i>Channel[001]</i>	12
5. [Setup] Page	13
5.1 <i><Setup> Page</i>	13
5.1.1 <i>[Comp] Setting</i>	13
5.1.2 <i>[Speed] Setting</i>	13
5.1.3 <i>[Beep] Feature</i>	13
5.1.4 <i>Temperature [Unit] Setting</i>	14
5.2 <i><COMP SETUP> Page</i>	14
5.2.1 <i>[001]</i>	14
5.3 <i><<USB-DISK SETUP> Page</i>	14
5.3.1 <i>[Create File]</i>	15
5.3.2 <i>Logging [Interval]</i>	15
5.3.3 <i>[01]</i>	15
6. System Configuration	16
6.1 <i><SYSTEM CONFIG> Page</i>	16
6.1.1 <i>[Language]</i>	16
6.1.2 <i>Setting the system [Date], [Time]</i>	16
6.1.3 <i>[ACCOUNT] Setting</i>	17
6.2 <i><SYSTEM INFORMATION> Page</i>	17
6.3 <i><SYSTEM SERVICE> Page</i>	18
7. Catalog Operation	19
7.1 <i>< CATALOG > Page</i>	19
8. Remote Control	20
8.1 <i>About RS-232C</i>	20
8.2 <i>About USB-Serial Interface(Optional)</i>	20
8.3 <i>To Select Baud Rate</i>	21
8.4 <i>SCPI Language</i>	21
9. Command Reference	22
9.1 <i>Terminator</i>	22
9.2 <i>Notation Conventions and Definitions</i>	22
9.3 <i>Command Structure</i>	22
9.4 <i>Header and Parameters</i>	23
9.5 <i>Command Reference</i>	24

9.5.1	MEAS SUBSYSTEM.....	24
9.5.2	SYST SUBSYSTEM.....	25
9.5.3	FETCH SUBSYSTEM.....	26
9.5.4	ERROR SUBSYSTEM.....	26
9.5.5	IDN SUBSYSTEM.....	26
10.	Accuracy.....	27
10.1	Accuracy.....	27
11.	Specification.....	28
11.1	General Specification.....	28
11.2	Specifications.....	29
11.3	Dimension.....	29

1. Unpacking and Inspection

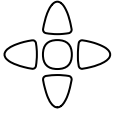

This chapter provides the following information:

- Packing List
- Power Supply
- Operation Environment
- Cleaning
- Instrument Handle

1.1 Packing List

After you receive the instrument, carry out checks during unpacking according to the following procedure. Check that the packing box or shock-absorbing material used to package the instrument has not been damaged.

Referring to the packing list, check that all packaged items supplied with the meter have been provided as per the specified options.

If damaged or accessories shortage, please contact the sales department or our agent.

1.2 Power Supply

AT4108/4116 can only be used in the following power supply conditions:

Voltage : 90V-260VAC

Power : 30VA MAX



Warning: To prevent risk of electric shock, connect the power supply ground. If the user replaces the power cord, make sure the power cord is connected to a reliable connection.

1.3 Operation Environment

Ensure the operation environment meets the following requirements

Temperature Range: 0°C ~ 55°C ,

Humidity: 23°C, < 70%RH

Altitude: 0~2000m

1.4 Cleaning

Do not attempt to clean the internal of AT4108/4116



Warning: Don't Use Organic Solvents (such as alcohol or gasoline) to clean the Instrument.

Use a dry cloth or a cloth slightly dipped in water to clean the casing.

1.5 Instrument Handle

Instrument handle can be adjusted, both hands gripping the handles on both sides, gently pull to both sides, and then rotate the handle. The handle can be adjusted to four positions, as shown below:

Figure 1-1 The instrument handle (schematics, panel graphics and is not)

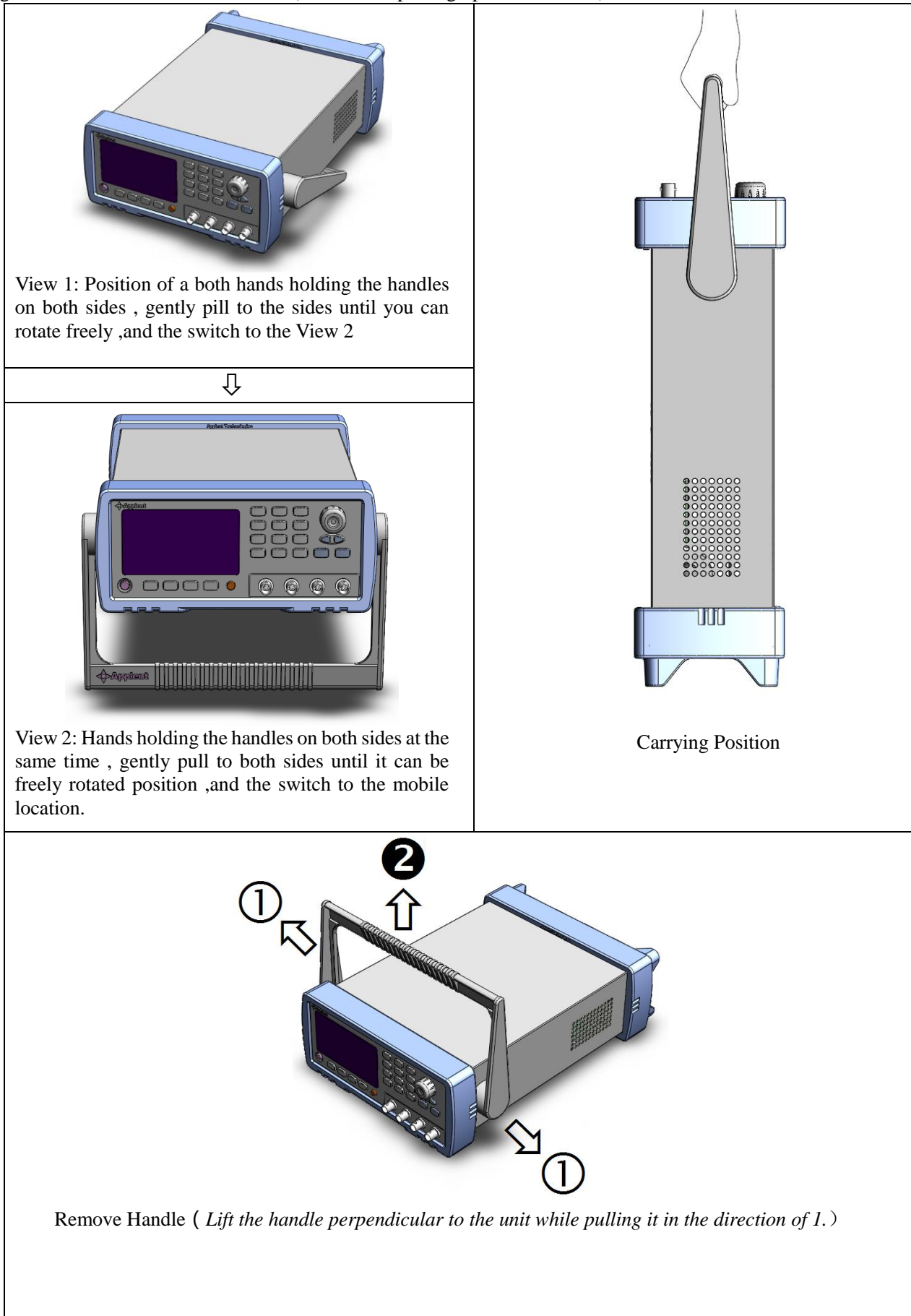

2. Overview

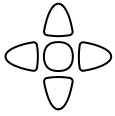

This chapter provides the following information:

- Overview
- Main Specification
- Main Function

2.1 Introduction

Thank you for purchasing AT4108/4116 Multi-channel Temperature Meter

The Applet AT4108/4116 adopts high-performance ARM microprocessor control, collects multi-channel temperature data simultaneously. The AT4108/4116 compatible with a variety of temperature sensors, fast response, data stability while with the burnout detection function. Also you can separately calibrate the data of each channel.

Configuration USB (virtual serial port) interface, through the software to achieve data acquisition, analysis and printing.

AT4108/4116 Supports USB disk storage and save the sampling data real-time.

2.2 Main Specifications

- Graduation: thermocouple J ,K, T
- Measurement Range: -200.0°C~1800.0°C (change according to different thermocouple type)
- Resolution: 0.1°C
- Channel: 8(AT4108)/16(AT4116) channels

2.3 Main Functions

2.3.1 Functions

1. Comparator Setting
2. Speed Setting
3. Beep Setting
4. Baud Rate Setting
5. Temperature Unit Setting

2.3.2 Sorting Setting

Build-in sorting data, each temperature data can be set both up limit and low limit

2.3.3 Correction Function

Each channel data can be corrected by the user.

2.3.4 FAT Save Function

Users are allowed to create file suffix [.csv], every channel data can be saved in USB memory (do not support removable hard disk)

2.3.5 System Setting

1. Keypad Lock Function
2. Switch both in English and Chinese
3. Date and Time Setting
4. Administrator and user accounts, password is available to the administrator

2.3.6 Remote Control

Support Max 115200bps baud rate, compatible with SCPI protocol, ASCII transfer

3. Startup

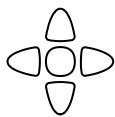

This chapter provides the following information:

- A tour of front and back panel
- Connection of the thermocouple

3.1 A tour of front and back panel

Figure 3-1 Front panel description

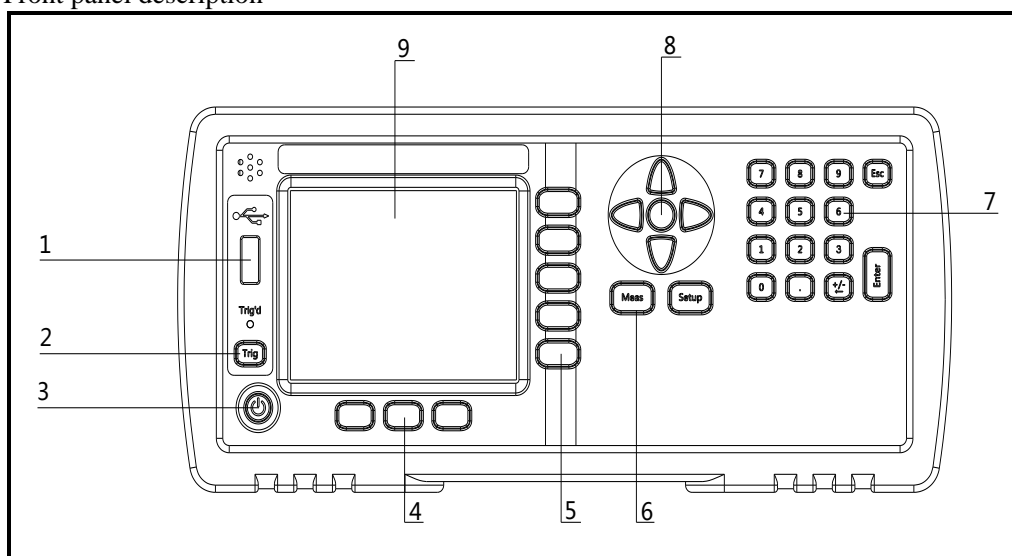

No	Description
1	USB Disk Port (USB-Host)
2	NG
3	Power Switch
4	System Key (Include File, System and Key Lock)
5	Soft Key
6	Menu key
7	Entry Key
8	Cursor Key
9	LCD Display

Figure 3-2 Back panel description

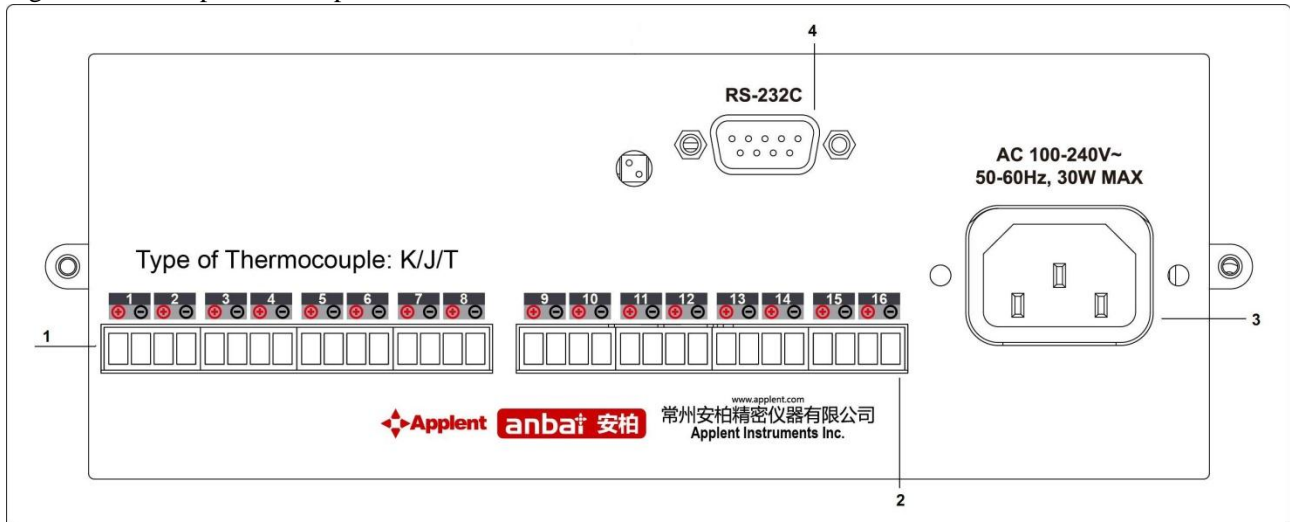

No	Description
1	1 # connection port
2	2 # connection port
3	Power outlet
4	RS232 interface

4. [Meas] Page

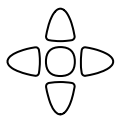

This chapter provides the following information:

- <Measure Display> Page

4.1 <MEASURE DISPLAY> Page

When press the [Meas] key, the <MEAS DISPLAY> page appears.

<MEASURE DISPLAY> page mainly highlights the measurement results, and current sorting results will be displayed in different font and color.

The following measurement controls can be set:

- Model - Chose the type of the thermocouple
- 001 thru 008 - Channel Setting

Figure 4-1 <Measure Display> Page

- AT4108 Display Page:



- AT4116 Display Page:



4.1.1 [MODEL]

The instrument supports 3 types thermocouple: T,K,J

- Steps to Set Sensor Model

Step 1	Press [Meas] key to enter <MEASURE DISPLAY> page
Step 2	Use the cursor keys to select [MODEL] field
Step 3	Use side soft keys to select
	Soft Key Function

	TC-T	Setting the thermocouple T type
	TC-K	Setting the thermocouple K type
	TC-J	Setting the thermocouple J type

4.1.2 Channel[001]

■ Steps to close or open the channel

Step 1	Press shortcut [Meas] to enter < MEASURE DISPLAY > page	
Step 2	Use the cursor keys to select [001] field	
Step 3	Use function key to select	
	Soft Keys	Function
	OFF	Close the current channel
	ON	Open the current channel



The same steps to close or open other channels

■ Steps to modify the channels of display

Step 1	Press [Meas] key to enter < MEASURE DISPLAY > page
Step 2	Use the cursor keys to select [001] field
Step 3	Input the channel number you wanted to display in current position by pressing numeric keys, press [Enter] to end.

*The same steps to close or open other channels

Table 4-1 Icon Function

Icon	Function
	USB-Disk attached
	Unit of current temperature
	Comparator Enabled

5. [Setup] Page

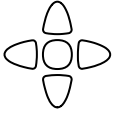

This chapter provides the following information :

- <SETUP> Page
- <COMP SETUP> Page
- <USB-DISK> Page

5.1 <Setup> Page

At any time, press [Setup] key to enter <Setup> page

<Setup> page can complete all settings concerned with the measurement, measurement and sorting results will not displayed and the instrument is in waiting state. Following parameters are included:

- Speed – Sampling Speed
- Beep – Beep Setting
- Unit – Temperature Unit Setting

Figure 5-1 <Setup> Page



5.1.1 [Comp] Setting

Comparator setting includes: ON and OFF

- To set up the comparator ON/OFF

Step 1	Press [Setup] key to enter <SETUP> page	
Step 2	Use the cursor keys to select [COMP] field	
Step 3	Use soft key to select	
	Soft Key	Function
	OFF	Turn off the comparator function and comp icon disappeared
	ON	Turn on the comparator function to ON and comp appeared

5.1.2 [Speed] Setting

There are three kinds speed: Slow, Middle and Fast

- Steps to set the speed

Step 1	Press [Setup] key to enter <SETUP> page	
Step 2	Use cursor keys to select [SPEED] field	
Step 3	Use function key to select	
	Soft Key	Function
	SLOW	Set the sampling speed to slow
	MED	Set the sampling speed to middle
	FAST	Set the sampling speed to fast

5.1.3 [Beep] Feature

Beep Feature includes: OFF and ON

■ Steps to set beep feature

Step 1	Press [Setup] key to enter < SETUP > page	
Step 2	Use cursor keys to select [BEEP] field	
Step 3	Use soft keys to select	
	Soft Key	Function
	OFF	Turn off the Beep feature
	ON	Turn on the Beep feature

5.1.4 Temperature [Unit] Setting

Units Includes: °C, K, °F.

■ Steps to Set the Unit:

Step 1	Press [Setup] key to enter < SETUP > page	
Step 2	Use cursor keys to select [UNIT] field	
Step 3	Use function keys to select	
	Soft Key	Function
	°C	Degree Celsius
	K	Degree Kelvin
	°F	Degree Fahrenheit

5.2 <COMP SETUP> Page

Press[Setup] key and then side soft key [COMP SET] to enter <COMP SETUP> page

In this page, you can set the HIGH and LOW limits for each channel

Figure 5-2 <COMP SETUP> Page



5.2.1 [001]

■ Steps to set LOW limit for 001 Channel

Step 1	Press [Setup] key to enter < SETUP > page
Step 2	Press [COMP SET] soft key to enter <COMP SETUP> page
Step 3	Use cursor keys to select [-200.0] field
Step 4	Use numeric key to input low limit value, then press [Enter] to end

■ Steps to set HIGH limit for 001 Channel

Step 1	Press [Setup] key to enter < SETUP > page
Step 2	Press [COMP SET] soft key to enter <COMP SETUP> page
Step 3	Use cursor keys to select [1800.0] field
Step 4	Use numeric key to input value, press [Enter] to end

■ Steps to Switch Channel Page

Step 1	Press [Setup] key to enter < SETUP > page
Step 2	Press [COMP SET] soft key to enter <COMP SETUP> page
Step 3	Press function key [PAGE UP] or [PAGE DOWN] to switch next page

5.3 <<USB-DISK SETUP> Page

Press [Setup] key and then soft key [USB DISK] to enter <USB-DISK SETUP > page

In this page, you can complete USB-Disk file settings

Figure 5-3 USB-Disk Setting Page

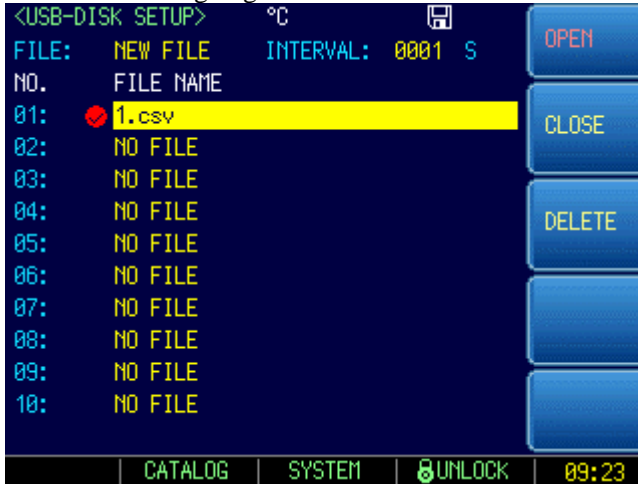

5.3.1 [Create File]

■ Steps to Create New File

Step 1	Press [Setup] key to enter [SETUP] page	
Step 2	Press soft key [USB DISK] to enter <USB-DISK SETUP> page	
Step 3	Use cursor key to select [FILE] field	
Step 4d	Use soft key to select	
	Function Key	Function
	CREAT FILE	Create a new [.csv] file, use numerical key to input the file name, press [Enter] to end.

5.3.2 Logging [Interval]

■ Steps to setup data logging interval

Step 1	Press [Setup] key to enter [SETUP] page
Step 2	Press soft key [USB DISK] to enter <USB-DISK SETUP> page
Step 3	Use cursor key to select [INTERVAL] field
Step 4	Use numeric key to input interval value (fast 5 second , slow 3600 second), press [Enter] to end

*The same steps to correct other channels

5.3.3 [01]

■ Steps to Bin-setting

Step 1	Press [Setup] key to enter [SETUP] page	
Step 2	Press soft key [USB DISK] to enter <USB-DISK SETUP> page	
Step 3	Use cursor key to select [No.] field	
Step 4	Use Soft key to select	
Step 5	Soft Key	Function
	OPEN	Open the current selected file. The data records will be stored into this file.
	CLOSE	Close the current selected file
	DELETE	Delete the current selected file

6. System Configuration

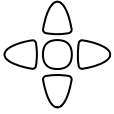

This chapter provides the following information:

- <SYSTEM CONFIG> Page
- <SYSTEM INFORMATION> Page
- <SERVICE> Page

6.1 <SYSTEM CONFIG> Page

In any place, just press shortcut [Meas] or [Setup] and select taskbar key [SYSTEM] to enter <SYSTEM CONFIG> page

<System Configuration> Page Includes the following settings:

- Language Setting
- Date/Time Setting
- Account/Password Setting
- Baud Setting

Figure 6-1 System Configuration Page



6.1.1 [Language]

AT4108/4116 supports both English and Chinese

■ Steps to setup language

Step 1	Press [Meas] or [Setup] key
Step 2	Press bottom soft key [SYSTEM] in taskbar to enter <SYSTEM CONFIG> page
Step 3	Use cursor key to select [LANGUAGE] field
Step 4	Use side soft key to select language
	Soft Key Function
	ENGLISH English
	CHINESE Chinese

6.1.2 Setting the system [Date], [Time]

AT4108/4116 features a built-in 24-hour clock.

■ Steps to setup date

Step 1	Press [Meas] or [Setup] key
Step 2	Press bottom soft key [SYSTEM] to enter <SYSTEM CONFIG> page
Step 3	Use cursor key to select [DATE] field
Step 4	Use soft key to set date
	Soft Key Function
	YEAR INCR+ +1 year
	YEAR DECR- -1 year
	MONTH INCR+ +1 month
	MONTH DECR- -1 month
	DAY INCR+ +1 day

	DAY DECR-	-1 day
--	-----------	--------

■ Steps to setup time

Step 1	Press [Meas] or [Setup] key	
Step 2	Select bottom soft key [SYSTEM], enter <SYSTEM CONFIG> page	
Step 3	Use cursor key to select [TIME] field	
Step 4	Use soft key to set time	
	Soft Key	Function
	HOUR INCR+	+1 Hour
	HOUR DECR-	-1 Hour
	MINUTE INCR+	+1 Minute
	MINUTE DECR-	-1Minute
	SECOND INCR+	+1Second
	SECOND DECR-	-1 Second

6.1.3 [ACCOUNT] Setting

The AT4108/4116 has two accounts, administrator and user.

Administrator: All functions can be configured by administrator except <SYSTEM SERVICE> page.

User: All functions can be configured by user except <SYSTEM SERVICE> page and <FILE> page.

■ Steps to set Account

Step 1	Press shortcuts [Meas] or [Setup]	
Step 2	Press bottom soft key [SYSTEM] to enter <SYSTEM CONFIG> page	
Step 3	Use cursor key to select [ACCOUNT] field	
Step 4	Use side soft key to change account	
	Function Key	Function
	ADMIN	Except page <SYSTEM SERVER > , all the functions are available to the administrator
	USER	Except page [SYSTEM SERVER] and [CATALOG], all the functions can be operated by the user.

■ Steps to input password for administrator:

Step 1	Press [Meas] or [Setup] key	
Step 2	Press bottom soft key [SYSTEM] to enter <SYSTEM CONFIG> page	
Step 3	Use cursor key to select [PASSWORD] field	
Step 4	Use side soft key to input password	
	Soft Key	Function
	CHANGE PASSWORD	Input 9 digits numeric password. If you forget the password, please contact our sales department.
	DELETE PASSWORD	

6.1.4 [BAUD]

AT4108/4116 supports baud

■ Steps to setup BAUD

Step 1	Press [Meas] or [Setup] key	
Step 2	Press bottom soft key [SYSTEM] in taskbar to enter <SYSTEM CONFIG> page	
Step 3	Use cursor key to select [BAUD] field	
Step 4	Use side soft key to select language	
	Soft Key	Function
	9600	
	19200	
	38400	
	57600	
	115200	

6.2 <SYSTEM INFORMATION> Page

When press the [Meas] or [Setup] key followed by [SYSTEM] bottom soft key, and then press [SYSTEM INFO] soft key, the <SYSTEM INFO> page appears.

There are no configurable options in the <SYSTEM INFO> page.

Figure 6-2 System Information Page

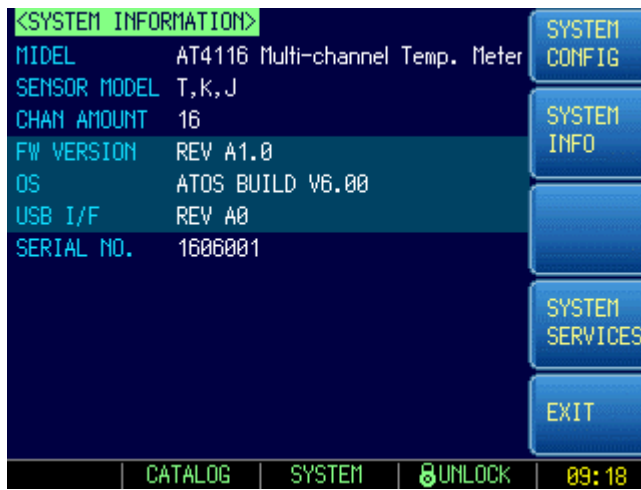

6.3 <SYSTEM SERVICE> Page



This page is used to calibrate data while input market. Non-professional person is forbidden.

7. Catalog Operation

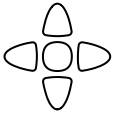

This chapter provides the following information

- <Catalog> Page

7.1 < CATALOG > Page

When press the [Meas] or [Setup] key followed by [CATALOG] bottom soft key, the <CATALOG> page appears. Some system settings will be saved into this file. The file will be loaded at power up.

<CATALOG> page includes the following settings

- FILE

Figure 7-1 <CATALOG> Page

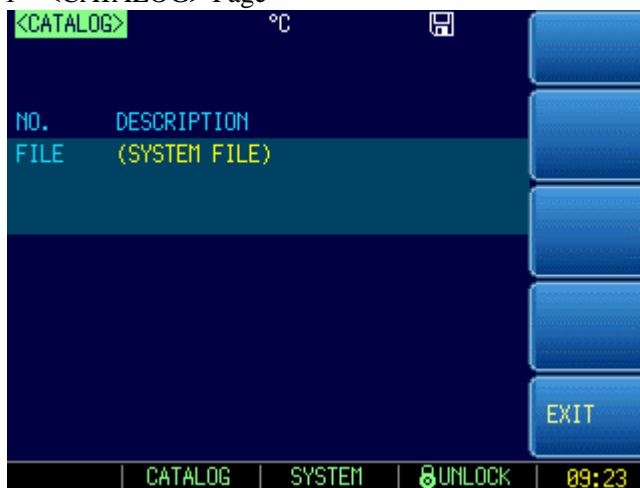

■ Steps to Save Settings

Step 1	Press [Meas] or [Setup] key	
Step 2	Press [CATALOG] bottom soft key to enter <CATALOG> page	
Step 3	Use cursor key to select [FILE] field	
Step 4	Use soft key to setup file.	
	Function Key	Function
	SAVE	Save the current settings
	RECALL	Load the saved settings
	ERASE	Delete the saved settings and the settings will be reset to system default.

8. Remote Control

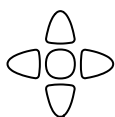

This chapter provides the following information to remotely control the AT4108/4116 via the RS-232C or USB interface. This chapter provides the following information

- About RS-232C
- About USB Interface
- Select Baud Rate.
- About SCPI

8.1 About RS-232C

You can connect a controller (i.e. PC and PLC) to the RS-232 interface using Applent RS-232 DB-9 cable. The serial port uses the transmit (TXD), receive (RXD) and signal ground (GND) lines of the RS-232 standard. It does not use the hardware handshaking lines CTS and RTS.



NOTE:
JUST ONLY Use an Applent (not null modem) DB-9 cable.
Cable length should not exceed 2m.

Figure 8-1 The RS-232 connector in the real panel

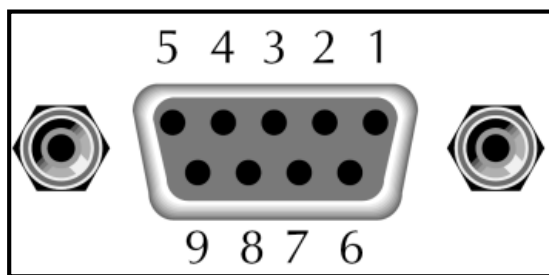

Table 8-1 RS-232 connector pinout

NAME	DB-25	DB-9	NOTE
DCD	8	1	Not Connection
RXD	3	2	Transmit data
TXD	2	3	Receive data
DTR	20	4	Not Connection
GND	7	5	Ground
DSR	6	6	Not Connection
RTS	4	7	Not Connection
CTS	5	8	Not Connection

- Make sure the controller you connect to AT4108/4116 also uses these settings.
The RS-232 interface transfers data using:
8 data bits,
1 stop bit,
And no parity.

8.2 About USB-Serial Interface(Optional)

The USB-Serial Interface allows you to connect AT4108/4116 to a USB port on your PC.



NOTE:
Please install the USB-Serial driver before using USB-Serial Interface.
The Applent USB-Serial interface model is ATN2.

Figure 8-2 USB-Serial Interface ATN2



8.3 To Select Baud Rate

Before you can control the AT4108/4116 by issuing RS-232 commands from built-in RS-232 controller connected via its DB-9 connector, you have to configure the RS-232 baud rate. The AT4108/4116's built-in RS-232 interface uses the SCPI language.

The configuration of RS-232

RS-232 configuration is as follows:

Data bits: 8-bit

Stop bits: 1-bit

Parity: none

To set up the baud rate

- Step 1. Press the [Setup] key
- Step 2. Use the cursor key to select [BAUD] field
- Step 3. Use the soft keys to select baud rate.

Soft key	Function
9600	
19200	
38400	
57600	
115200	Recommend

8.4 SCPI Language

Standard Commands for Programmable Instruments (SCPI) is fully supported by the



NOTE:
AT4108/4116 ONLY supports the SCPI Language.

9. Command Reference

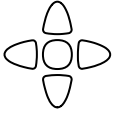

This chapter contains reference information on programming AT4108/4116 with the SCPI commands.

- Terminator
- Notation Conventions and Definitions
- Header and Parameters
- Command Reference

This chapter provides descriptions of all the AT4108/4116's available RS-232 commands which correspond to Standard Commands for Programmable Instruments (SCPI) command sets, listed in functional subsystem order.

9.1 Terminator

<NL> : The EOI line is asserted by New Line or ASCII Line Feed character (decimal 10, Hex 0x0A , or ASCII '\n')

9.2 Notation Conventions and Definitions

The following conventions and definitions are used in this chapter to describe RS-232 operation.

< > Angular brackets enclose words or characters that are used to symbolize a program code parameter or an RS-232 command.

[] A square bracket indicates that the enclosed items are optional.

\n Command Terminator

9.3 Command Structure

The AT4108/4116 commands are divided into two types: Common commands and SCPI commands.

The common commands are defined in IEEE std. 488.2-1987, and these commands are common for all devices. The SCPI commands are used to control all of the AT4108/4116's functions.

The SCPI commands are tree structured three levels deep. The highest level commands are called the subsystem commands in this manual. So the lower level commands are legal only when the subsystem commands have been selected.

A colon (:) is used to separate the higher level commands and the lower level commands.

Semicolon (;) A semicolon does not change the current path but separates two commands in the same message.

Figure 9-1 Command Tree Example

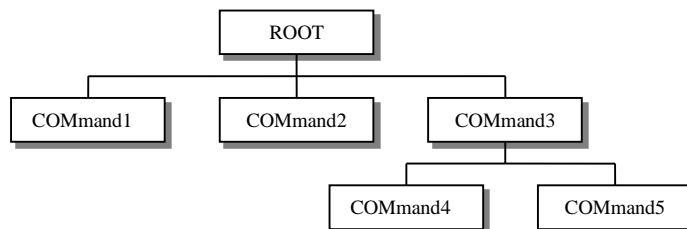

Example:

```

ROOT:COMmand3:COMmand5 ppp
ROOT Subsystem Command
  COMmand3 Level 2
    COMmand5 Level 3
      ppp Parameter
  
```

- The basic rules of the command tree are as follows.

- Letter case (upper and lower) is ignored.
For example,
ROOT:COMMAND3 = root:command3
- Spaces (_ used to indicate a space) must not be placed before and/or after the colon (:).
For example,
☒ root_: command3 → ☑ root:command3
- The command can be completely spelled out or in abbreviated.(The rules for command abbreviation are described later in this section)
For example,
root:command3 = root:com3
- The command header should be followed by a question mark (?) to generate a query for that command.
For example,
root:com3?
- The semicolon (;) can be used as a separator to execute multiple commands on a single line. The multiple command rules are as follows.
Commands at the same level and in the same subsystem command group can be separated by a semicolon (;) on a multiple command line.
For example,
root:com3:com5 ppp;com4 ppp
To restart commands from the highest level, a semicolon (;) must be used as the separator, and then a leading colon (:), which shows that the restarted command is a command at the top of the command tree, must follow.
For example,
root:com3:com5 ppp;[:root:com1 ppp



The AT4108/4116 accepts the three forms of the same SCPI commands: all upper case, all lower case, and mixed upper and lower case.

9.4 Header and Parameters

The commands consist of a command header and parameters. (See the following.)

Example: comp:nom 100.0e3

Header Parameter

- Headers can be of the long form or the short form. The long form allows easier understanding of the program code and the short form allows more efficient use of the computer.
- Parameters may be of two types as follows.
 - (A) Character Data and String Data Character data consists of ASCII characters. The abbreviation rules are the same as the rules for command headers.
 - (B) Numeric Data
 - (a) <integer>: For example, 1,+123,-123
 - (b) <float>: For example, 1.23e3, 5.67e-3, 123k, 1.23M, 2.34G, 1.234
 - (c) <scifloat>: For example, +1.23456e+03

The available range for numeric data is 9.9E37. When numeric data is used as a parameter, the suffix multiplier mnemonics and suffix units (The suffix multiplier must be used with the suffix unit) can be used for some commands as follows.

Table 9-1 Multiplier Mnemonics

Definition	Mnemonic
1E18 (EXA)	EX
1E15 (PETA)	PE
1E12 (TERA)	T
1E9 (GIGA)	G
1E6 (MEGA)	MA
1E3 (KILO)	K
1E-3 (MILLI)	M
1E-6 (MICRO)	U

1E-9 (NANO)	N
1E-12 (PICO)	P
1E-15 (PEMTO)	F
1E-18 (ATTO)	A

9.5 Command Reference

All commands in this reference are fully explained and listed in the following functional command order.

- MEAS Subsystem
- SYST Subsystem
- FETCH Subsystem
- ERROR Subsystem
- IDN?

9.5.1 MEAS SUBSYSTEM

The MEAS Subsystem command group sets the meas page.

Figure 9-2 MEAS Command Tree

Meas	:MODEL	{tc-t,tc-k,tc-j}
	:RATE	{fast,med,slow}
	:KEYLOCK	{on,off}
	:CHAN	<integer>

9.5.1.1 MEAS:MODEL

The :MODEL command sets the Model.

Command Syntax	MEAS:MODEL <tc-t,tc-k,tc-j>
Example	SEND> MEAS:MODEL TC-T<NL> //Set MODEL to T-type thermocouple
Query Syntax	MEAS:MODEL?
Query Response	< tc-t,tc-k,tc-j ><NL>
Example	SEND> MEAS:MODEL?<NL> RET> tc-t<NL>

9.5.1.2 MEAS:RATE

The :RATE command sets the Speed.

Command Syntax	MEAS:RATE <fast,med,slow>
Example	SEND> MEAS:RATE fast<NL> //Set to fast speed
Query Syntax	MEAS:RATE?
Query Response	<fast,med,slow><NL>
Example	SEND> MEAS:RATE?<NL> RET> fast<NL>

9.5.1.3 MEAS:KEYLOCK

The :KEYLOCK command sets the KEYPAD.

Command Syntax	MEAS:KEYLOCK <on,off>
Example	SEND> MEAS:KEYLOCK off<NL> //Set to close Keypad
Query Syntax	MEAS:KEYLOCK?
Query Response	<on,off><NL>
Example	SEND> MEAS:KEYLOCK?<NL> RET> on<NL>

9.5.1.4 MEAS:CHAN

The :CHAN command sets the Channel.

Command Syntax	MEAS:CHAN <integer>
Parameter	<integer> Convert from decimal to binary , four high address bits , the lower 8 bits of the channel control bits , example: address bits 1,8 channel fully open , binary 1,11111111 , The channel label starting from the low minimum bit channel CH01 , BIT for each channel corresponding to 1 to open the channel , and 0 to close the channel
Example	SEND> MEAS:chan 510<NL> //Set to close channel 9
Query Syntax	MEAS:CHAN?
Query Response	<integer , integer><NL>
Example	SEND> MEAS:CHAN?<NL> RET> 255,254<NL>

9.5.2 SYST SUBSYSTEM

The SYST Subsystem command group sets the setup page.

Figure 9-3 SYST Command Tree

Meas	:COMP	{on,off}
	:BEEP	{on,off}
	:UNIT	{cel, kel, fah}

9.5.2.1 SYST:COMP

The :COMP command sets the comp feature.

Command Syntax	MEAS:COMP <on,off>
Example	SEND> SYST:comp on<NL> //Set to open comparator
Query Syntax	MEAS:comp?
Query Response	<on,off><NL>
Example	SEND> SYST:comp?<NL> RET> on<NL>

9.5.2.2 SYST:BEEP

The :BEEP command sets the beep feature.

Command Syntax	MEAS:BEEP <on,off>
Example	SEND> SYST:beep on <NL> //Set to open beep
Query Syntax	MEAS:beep?
Query Response	<on,off><NL>
Example	SEND> SYST:beep?<NL> RET> on<NL>

9.5.2.3 SYST:UNIT

The :UNIT command sets the unit feature.

Command Syntax	MEAS:UNIT <cel, kel, fah>
Parameter	<cel, kel, fah> cel: Degrees Celsius kel: Degrees Kelvin fah: Fahrenheit
Example	SEND> SYST:unit cel<NL> //Set to Degrees Celsius
Query Syntax	MEAS:unit?
Query Response	<°C, K, F><NL>

Example	SEND> SYST:unit?<NL> RET> °C<NL>
----------------	---------------------------------------------------------------------

9.5.3 FETCH SUBSYSTEM

The FETCh subsystem command group is a sensor-only command which retrieves the measurement data taken by measurement(s) initiated by a trigger, and places the data into the output buffer

Figure 9-4 FETCH Command Tree

fetch?	
---------------	--

9.5.3.1 FETCH?

The FETCh? retrieves the latest measurement data and comparator result.

Query Syntax	Fetch?
Query Response	<float, float, float><NL>... //Returns the number related to the number of channels
Example	SEND> fetch?<NL> RET> +1.00000e-05, +1.00000e-05, +1.00000e-05<NL>

9.5.4 ERROR SUBSYSTEM

The ERRor subsystem retrieves last error information.

Query Syntax	ERROR?
Query Response	Error string
Example	SEND> ERR?<NL> RET> no error<NL>

9.5.5 IDN SUBSYSTEM

The *IDN? query returns the instrument ID.

Query Syntax	IDN? Or *IDN?
Query Response	<MODEL>, <Revision>, <SN>, <Manufacturer>

10. Accuracy

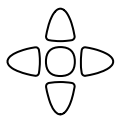

This chapter provides the following information:

- Accuracy

10.1 Accuracy

Instrument Accuracy does not include the standard contact compensation Precision.

Model	Range (°C)	Accuracy (°C)
T	-150°C to 0°C	±1.0°C
	0°C to 400°C	±0.8°C
K	-100°C to 0°C	±1.2°C
	0°C to 1350°C	±0.8°C
J	-100°C to 0°C	±1.0°C
	0°C to 1200°C	±0.7°C

Standard connection compensation need to add $\pm 0.5^\circ\text{C}$ based on thermocouple measuring accuracy. The measuring accuracy of thermocouple sensor gives priority to sensor supplier's standard.

11. Specification

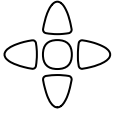

This chapter provides the following information:

- General Specification
- Specifications
- Dimension

11.1 General Specification

The Data is Achieved under the Following Conditions:

- Temperature: $23^{\circ}\text{C} \pm 5^{\circ}\text{C}$
- Humidity: $\leq 65\%$ R.H.
- Warm-up Time: > 60 minutes
- Calibration Time : 12 months

Test Environment:

- Temperature and humidity range: $15^{\circ}\text{C} \sim 35^{\circ}\text{C}$, 80% RH or less
- Storage temperature and humidity range: $10^{\circ}\text{C} \sim 40^{\circ}\text{C}$, 10~90% RH

Thermocouple Type:	T,K,J,N,E,S,R,B
Display:	5 digits
Test Speed:	Fast, Medium, Slow
Max Reading:	1800.0°C
Min Reading:	-200.0°C
Data Logger:	USB Disk
Beep:	ON/OFF
Interface:	RS232 to USB Interface
Program Language:	SCPI
Auxiliary Function:	Keypad Lock

11.2 Specifications

- 3.5 inches, true color 16M, TFT-LCD display
- Comparator (Sorting) Function.
- Keypad Lock Function
- Language: English and Chinese
- Build-in RS232 interface
- Compatible SCPI Instruction Set

11.3 Dimension

